

GUEST®



LISTED
Battery Charger
30TA



MODEL 2608

6 AMP ON BOARD BATTERY CHARGER OWNER'S MANUAL

Connections at a glance:

The Guest ChargePro Model 2608 is designed to be used as an on board charger for lead acid batteries (flooded cell or AGM types) and gel cell batteries. We recommend that you set up the charger near the battery you wish to charge, and make connections in the following order:

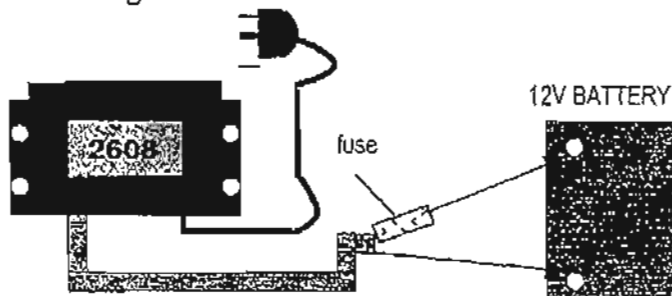

1. Charger POS (white wire with fuse) to battery " + ".
2. Charger NEG (black wire) to battery " - ".
3. Plug AC line cord into a GFCI protected wall socket.
4. Remove connections in the reverse order.

SAVE THESE INSTRUCTIONS

1. INTRODUCING THE CHARGER

The GUEST ChargePro 2608 is designed to both recharge your battery, and extend your battery's life in applications where it is stored for long periods of time. The 2608 is a "3-stage" electronic battery charger. Rainproof, lightweight, silent, and completely automatic, it produces 12 Volts DC at a full 6 Amps, while using much less AC current than older chargers. Unlike automotive "trickle" chargers, the 2608 will not boil off the electrolyte in a lead-acid battery when left unattended. When the 2608 is attached to your battery and plugged into a standard 115 Volt / 60 Hz AC outlet, the red and green LED's let you know the unit is *recharging* and *maintaining* your battery. This sophisticated device is ideal for recharging and maintaining the 12VDC battery in your boat, electric vehicle or cart, ATV, snowmobile or motorcycle.

2. IMPORTANT SAFETY INSTRUCTIONS

This manual contains important safety and operating instructions for the charger. Read the entire manual before using. Also read all instructions and cautions for and on the charger, batteries and equipment in the vicinity of the batteries.

WARNINGS

THIS CHARGER SHOULD BE USED TO CHARGE ONLY 12VOLT DC LEAD ACID OR GEL CELL TYPE BATTERY SYSTEMS. USE ON OTHER THAN A 12 VDC SYSTEM CAN CAUSE THE BATTERY TO EXPLODE AND CAUSE PERSONAL INJURY.

RISK OF EXPLOSIVE GASES! WORKING IN THE VICINITY OF A LEAD ACID BATTERY IS DANGEROUS. A BATTERY GENERATES EXPLOSIVE GASES DURING NORMAL OPERATION. THEREFORE IT IS OF UTMOST IMPORTANCE THAT EACH TIME BEFORE USING YOUR CHARGER YOU FOLLOW THE INSTRUCTIONS EXACTLY.

Personal Safety Precautions

Adhere to the following personal safety precautions when installing or working with the chargers:

1. Someone should be within voice range or close enough to come to your aid when you work near a lead-acid battery.
2. Have plenty of fresh water and soap nearby in case battery acid contacts skin, clothing, or eyes.
3. Wear complete eye protection and clothing protection. Avoid touching eyes while working near a battery.
4. If battery acid contacts skin or clothing, wash them immediately with soap and water. If acid enters the eye, flood the eye with cold, running water for at least ten minutes and get medical attention.
5. Never smoke or allow an open flame in the vicinity of the battery.
6. Do not drop a metal tool onto the battery. It may spark, short circuit the battery and may cause an explosion.
7. Remove all personal metal items such as rings, bracelets, necklaces, and watches when working near a lead-acid battery. A battery can produce short circuit currents high enough to weld a ring or the like to metal, causing a severe burn.

Preparing to Charge Precautions

Before charging a battery with the charger, read the following precautions:

1. Do **NOT** operate the charger if the input or output cables or an LED is damaged.
2. Make sure all accessories on the product you are charging are **OFF**.
3. If the battery or batteries must be removed from the product, always remove the grounded terminal from the battery first.
4. Be sure the area around the battery is well ventilated while the battery is being charged. Gas can be forcefully blown away using a piece of cardboard or other non-metallic material as a "hand fan".
5. Clean battery terminals. Be careful to keep corrosion from coming in contact with eyes.
6. Add distilled water in each cell until battery acid reaches levels specified by the battery manufacturer. Do not overfill. For a battery without cell caps, carefully follow the manufacturer's recharging instructions.
7. Never allow the ring terminals to touch each other.
8. **NEVER** charge a frozen battery.

Grounding Precautions

DANGER

Do not operate this charger with a two bladed adapter plug or extension cord. Doing so can result in serious personal injury.

CAUTION: To reduce the risk of shock, connect only to a properly grounded outlet.

3. INSTALLING THE CHARGER

Choosing Charging Location

The charger should have at least eight inches of unobstructed area on all sides of the unit for effective cooling. The case of this charger will become warm during operation. Do not install the charger on carpeted, upholstered, or varnished surfaces. Keep the AC power cord connection as short as possible especially when using an extension cord.

Mounting the Charger

1. Use corrosion resistant ¼" dia. bolts, backed by a flat washer, and secured to the mounting surface with a split-ring lock washer.
2. Hold the charger to the mounting surface and mark the holes.
3. Remove the charger and drill the mounting holes.
4. Align the charger and assemble the mounting hardware. Secure.

Making DC Connections







1. Check polarity of the battery posts. The POSITIVE (POS., P, +) battery post usually has a larger diameter than the NEGATIVE (NEG., N, -) post.
2. Attach the red POSITIVE ring terminal (identified by the red POSITIVE label on the red or white output wire) from the charger to the POSITIVE post of the battery. Attach the black NEGATIVE ring terminal (black output wire) from the charger to the NEGATIVE post of the battery.
3. When disconnecting the battery charger, first disconnect the AC power cord, then remove the black (NEGATIVE) ring terminal from the battery terminal and then remove the red (POSITIVE) ring terminal from battery terminal.

Making AC Power Connections

After securing the battery connections, plug the AC line cord into an available AC outlet that is protected by a Ground Fault Circuit Interrupter (GFCI) breaker. Keep the AC power cord connection as short as possible especially when using an extension cord.

4. OPERATING THE CHARGER

The LED Function Chart below describes the charging process.

Display	Operating condition
Red  Green 	<p>When the red LED is on, it indicates that your battery is discharged and the 2608 is recharging at the "BULK" rate (stage 1). This charging rate is 6 Amps.</p> <p>While the red LED is on, the voltage measured (with the charger on) will be 11.8 to 14 Volts.</p> <p>If the red LED stays on for more than 24 hours, refer to Problem 1 in the troubleshooting section in this manual.</p>
Red  Green 	<p>When both the green and the red LED's are on, the 2608 is charging at an "ABSORPTION" rate of between 1.5 and 5 Amps (stage 2). This mode of charging gradually "tops off" your battery, and reduces harmful sulfating. While both LED's are on, the voltage measured (with the charger on) should be approx. 14.0 to 14.5VDC.</p> <p>If both LED's stay on longer than 24 hours, refer to Problem 2 in the troubleshooting section in this manual.</p>
Red  Green 	<p>When the green LED is on, the 2608 is charging at a "FLOAT" or "MAINTENANCE" rate of less than 1.5 Amps, (stage 3). Your battery is now 90% charged and ready for use. This "float" charging current will gradually decrease to as low as 0.1 Amps as the battery reaches 100% charge. It will now be kept at full charge without over-charging.</p> <p>If the green LED stays on when your battery is known to be low, refer to Problem 3 in the troubleshooting section in this manual.</p>

Guest Model 2608 Charging Method

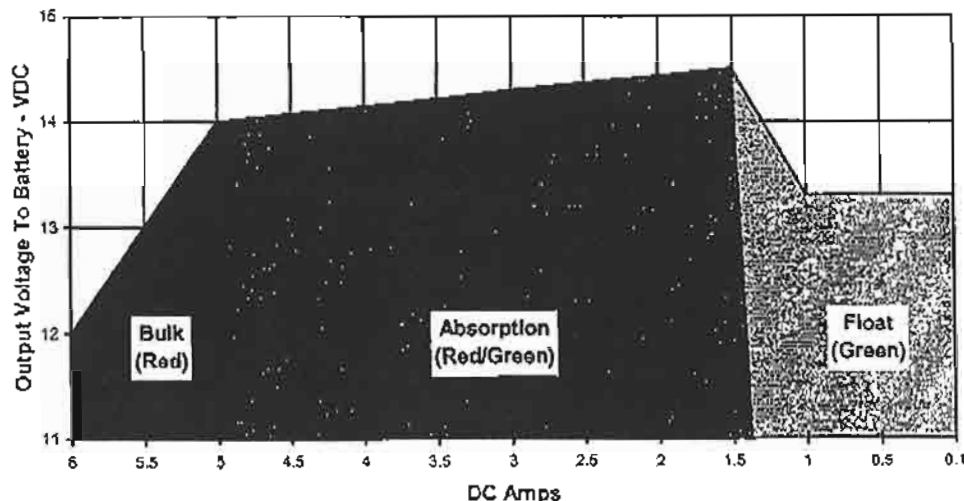

5. TROUBLESHOOTING

Problem	Cause	Solution
1. Red LED stays on for more than 24 Hrs.	<ol style="list-style-type: none">1. One or more defective or damaged cells.2. Charger has reduced its output voltage below the normal level due to a DC overload or a DC short.3. On-board DC systems are drawing more current than the charger can replace.	<ol style="list-style-type: none">1. Load test the battery and replace if necessary.2. Remove the source of the overload or short. Disconnect the charger's black (NEGATIVE) ring terminal from the battery. Reapply AC power and the green LED only should now light.3. Turn off all DC equipment while charging.
2. The red and green LED's stay on for more than 24 Hrs.	<ol style="list-style-type: none">1. On-board DC systems are drawing between 1.5 – 5A.2. One or more defective or damaged cells.3. Extremely low AC voltage at the battery charger	<ol style="list-style-type: none">1. Turn off all DC equipment while charging.2. Load test the battery and replace if necessary.3. Apply a higher AC voltage source or reduce the length of the extension cord.
1. Green LED stays on when the battery is known to be low.	<ol style="list-style-type: none">1. Open DC output fuse.2. Faulty or contaminated terminal connections.3. One or more defective or damaged cells.	<ol style="list-style-type: none">1. Replace DC output fuse with a Bussmann (AGX-10).2. Clean and tighten or repair all terminal connections.3. Load test the battery and replace if necessary.
2. Neither of the LED's turn on when the AC power is applied.	<ol style="list-style-type: none">1. No AC power available at the charger2. Component failure	<ol style="list-style-type: none">1. Connect AC power or reset the AC breaker on the main panel2. Return charger to the Guest Service Dept.

6. MAINTAINING THE CHARGER

Periodically clean both battery terminals with baking soda and tighten all connections. No other maintenance on the charger is required.

7. SPECIFICATIONS

Output:	
Charging:	12 Volts DC (min.) at 6 Amps
Maintaining:	13.30 Volts DC at 0.1 Amps
Input:	
Rated AC Voltage	100 – 130 VAC, 50/60 Hz
Current Draw	1.6 Amps at full output
Maximum recommended battery size:	
For recharging:	Up to 150 Amp-Hours
Maintenance only:	Up to 300 Amp-Hours
Physical Dimensions:	
Height:	3.5 in. (8.9 cm.)
Width:	6.4 in. (16.3 cm.)
Depth:	2.1 in. (5.3 cm.)
Weight:	3.5 lb. (1.6 kg)

FCC Class A EMC Notice

This equipment has been tested and found to comply with the limits for a Class A digital device, pursuant to part 15 of the FCC Rules. These limits are designed to provide reasonable protection against harmful interference when the equipment is operated in a commercial environment. This equipment generates, uses and can radiate radio frequency energy and, if not installed and used in accordance with the instructions, may cause harmful interference to radio communications. Operation of this equipment in a residential area is likely to cause harmful interference in which case the user will be required to correct the interference at his own expense.

If this equipment does cause harmful interference to radio or television reception, which can be determined by turning this equipment off and on, the user is encouraged to try to correct the interference by one or more of the following measures:

- Reorient or relocate the receiving antenna.
- Increase the separation between the equipment and receiver.
- Connect the equipment into an outlet on a circuit different from that to which the receiver is connected.

LIMITED WARRANTY

For two (2) years from the date of purchase, The Guest Co. will, at its discretion, repair or replace for the original consumer, free of charge, any parts found defective in material or workmanship.

Proof of purchase is required: A computerized register receipt is required. Hand-written receipts are not accepted for warranty proof of purchase.

There is no other expressed warranty. Implied warranties, including those of merchantability and fitness for a particular purpose, are limited to two years from the date of purchase. This is the exclusive remedy and consequential damages are excluded where permitted by law.

The Guest Co.
95 Research Parkway
Meriden, CT 06450, USA

Tel: (203) 235-4421
Fax: (203) 235-0039

email: vfqst@aol.com
website: www.questco.com

GUEST

PRODUCT SPECIFICATION

PS - 727860

Rev.

A

1.0 **PRODUCT NUMBER:** 2608A

2.0 **DESCRIPTION:** The 2608A is an automatic 3-Stage battery charger with 1.6 amp, 12 Vdc output.

2.1 Dimensions (reference)

3.5 in	Height	6.4 in	Width	2.25 in	Depth
8.9 cm		16.3 cm		8 cm	

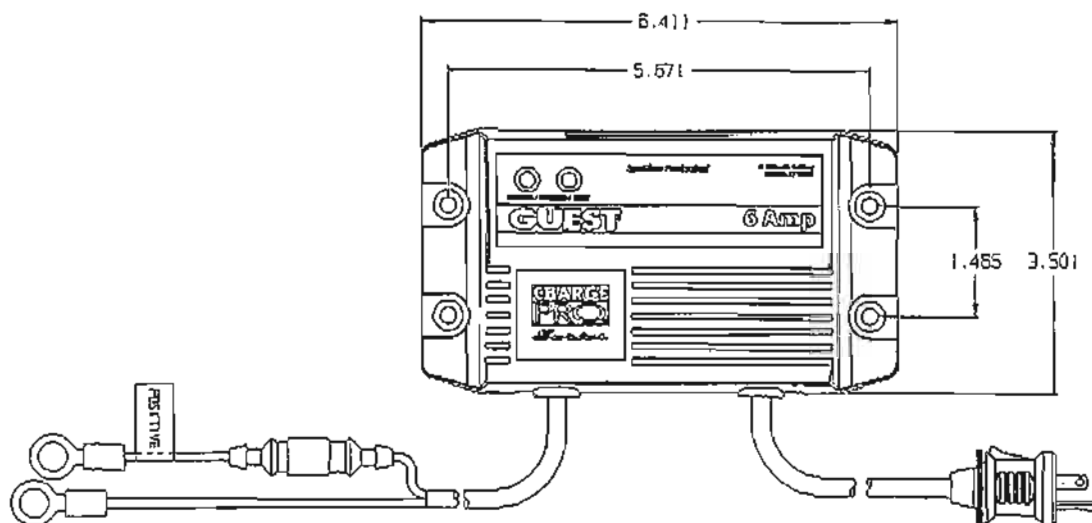

Weight (reference)

Approximately 4 lb. (1.81 kg)

2.2 Cabling

6' AC Cable 18/3 SJT cord with standard 115 Vac AC connector

4' DC output cable, 18 awg wires, fused with ring terminals

2.3 Features

- Watertight, shockproof, and corrosion proof
- Short Circuit and thermal protection
- LED status indicator
- Reverse Polarity Protected

Printed copies of this specification are for information purposes only and are uncontrolled. Printed copies are **REFERENCE SPECIFICATIONS** after the date of printing. This document was printed on 9 September, 2005.

GUEST

PRODUCT SPECIFICATION

3.0 ELECTRICAL CHARACTERISTICS:

3.1	Battery Recommendation	
	Maximum Battery Size:	72 Amp Hours
	Battery Type:	SLA, AGM, Gel
	Maximum Recharge Time:	12 hours
3.1	Input Rating	
	Input Voltage Range:	100 – 130VAC
	Input Current Rating:	2 Amps maximum
3.2	Float – Maintenance Stage	
	Float Voltage:	13.1 – 13.5V
	Float Current:	0 – 1A
	LED status:	GREEN LED ON
3.3	Absorption -	
	Absorption Voltage:	13.2 – 14.8 V
	Absorption Current:	2.5 – 4.5 A
	LED status:	GREEN LED AND RED LED ARE ON
3.4	Full Load – Bulk Stage	
	Full Load Voltage:	11.5 – 13.5 VDC
	Full Load Current:	4.5A – 6A
	LED status:	GREEN LED OFF, RED LED IS ON
3.5	Reverse Polarity Protection	
	Active Reverse polarity	
3.6	Short circuit/ overload Protection	
	Maximum Short Circuit Current:	2.5 A (typical)
	Current Limit:	8 A (+/- 10 %)
3.7	Inhibit	
	N/A	

4.0 TEMPERATURE CHARACTERISTICS:

4.1	Operating Temperature Range	
	Minimum Temperature:	-20 °C
	Maximum Temperature:	50 °C
4.2	Storage Temperature Range	

GUEST

PRODUCT SPECIFICATION

Maximum Temperature:

70 °C

5.0 AGENCY CERTIFICATION:

5.1 EMI/RFI

This product meets FCC class A for conducted and radiated emissions (EMI and RFI).

5.2 UL

N/A

6.0 WARRANTY

This product has a 2 year warranty.

7.0 REVISION HISTORY:

The table below identifies the revision history of this procedure.

Revision	Product Specification Change Summary	Initials	Effective Date
A	Initial Release	NBM	11/07/03

Originator: Nate Minegar	Position: Engineer
Approved by: Brian Tofedt	Position: Engineering Manager

Printed copies of this specification are for information purposes only and are uncontrolled. Printed copies are **REFERENCE SPECIFICATIONS** after the date of printing. This document was printed on 9 September, 2005.



Trolling Charger Series OWNER'S MANUAL

ON BOARD BATTERY CHARGERS

<u>Models</u>	<u>Amperage</u>	<u>No. Of Banks</u>	<u>Volts</u>
2607A	3, 3 Amps	2 Bank	12/24
2608A	6 Amps	1 Banks	12
2610A	5, 5 Amps	2 Banks	12
2611A	5, 5 Amps	2 Banks	12/24

See Connection diagrams for warnings.

IMPORTANT NOTICE

This manual contains important safety and operating instructions for the charger. Read the entire manual before using. Also read all instructions and cautions for and on the charger, batteries and equipment in the vicinity of the batteries.

1. INTRODUCING THE CHARGER

The Guest model 2607A, 2608A, 2610A and 2611A are designed to both recharge your batteries, and extend your battery's life in applications where it is stored for long periods of time. They are "3-stage" electronic, completely automatic, lightweight, silent, battery chargers and each output produces 12 Volts DC at either a full 3, 6 or 5 Amps (model specific), while using much less AC current than other charger types. Unlike automotive "trickle" chargers, the 2607A, 2608A, 2610A and 2611A will not boil off the electrolytes in properly installed and maintained batteries. The red and green LED's, mounted on the charger face, let you know the unit is *recharging* and *maintaining* your batteries. This sophisticated device is ideal for recharging and maintaining the 12VDC batteries in your boat, electric vehicle or cart, ATV, snowmobile or motorcycle.

SAVE THESE INSTRUCTIONS

WARNINGS

THIS CHARGER SHOULD BE USED TO CHARGE ONLY LEAD ACID OR GEL CELL TYPE BATTERIES. USE ON OTHER BATTERY TYPES MAY EXPLODE AND CAUSE PERSONAL INJURY.

RISK OF EXPLOSIVE GASES! WORKING IN THE VICINITY OF LEAD ACID BATTERIES IS DANGEROUS. BATTERIES GENERATE EXPLOSIVE GASES DURING NORMAL OPERATION. THEREFORE IT IS OF THE UTMOST IMPORTANCE THAT EACH TIME BEFORE USING YOUR CHARGER YOU FOLLOW THE INSTRUCTIONS EXACTLY.

Personal Safety Precautions

Adhere to the following personal safety precautions when installing or working with the chargers:

1. Someone should be within voice range or close enough to come to your aid when you work near a lead-acid battery.
2. Have plenty of fresh water and soap nearby in case battery acid contacts skin, clothing, or eyes.
3. Wear complete eye protection and clothing protection. Avoid touching eyes while working near a battery.
4. If battery acid contacts skin or clothing, wash them immediately with soap and water. If acid enters the eye, flood the eye with cold, running water for at least ten minutes and get medical attention.
5. Never smoke or allow an open flame in the vicinity of the battery.
6. Do not drop a metal tool onto the battery. It may spark, short circuit the battery and may cause an explosion.
7. Remove all personal metal items such as rings, bracelets, necklaces, and watches when working near a lead-acid battery. A battery can produce short circuit currents high enough to weld a ring or the like to metal, causing a severe burn.

Preparing to Charge Precautions

Before charging a battery with the charger, read the following precautions:

1. Do **NOT** operate the charger if the cables or an LED is damaged.
2. Make sure all accessories on the product you are charging are **OFF**.
3. If the battery or batteries must be removed from the product, always remove the grounded terminal from the battery first.
4. Be sure the area around the battery is well ventilated while the battery is being charged. Gas can be forcefully blown away using a piece of cardboard or other non-metallic material as a "hand fan".
5. Clean battery terminals. Be careful to keep corrosion from coming in contact with eyes.

6. Add distilled water in each cell until battery acid reaches levels specified by the battery manufacturer, if applicable. Do not overfill. For all batteries, carefully follow the manufacturer's recharging instructions.
7. Never allow the ring terminals to touch each other.
8. **NEVER** charge a frozen battery.

AC Connection and Grounding Precautions

DANGER

DO NOT OPERATE THIS CHARGER WITH A TWO BLADED ADAPTER PLUG OR EXTENSION CORD. DOING SO CAN RESULT IN SERIOUS PERSONAL INJURY. AFTER SECURING THE BATTERY CONNECTIONS, PLUG THE AC LINE CORD INTO AN AVAILABLE AC OUTLET THAT IS PROTECTED BY A GROUND FAULT CIRCUIT INTERRUPTER (GFCI) BREAKER.

CAUTION: To reduce the risk of shock, connect only to a properly grounded outlet.

NOTE: AC Line Cord color coding is EU style. Line = Brown, Neutral = Blue, Ground = Green

2. INSTALLING THE CHARGER

Choosing Charging Location

The charger should have at least eight inches of unobstructed area on all sides of the unit for effective cooling. The case of this charger will become warm during operation. Because the charger is convection cooled (airflow over the back of the charger), the optimum mounting position for the charger is vertical. Mounting on its back on a horizontal surface may cause the charger to slightly reduce amperage output due to the thermal protection built in. Do not install the charger on carpeted, upholstered, or varnished surfaces.

Mounting the Charger

1. Use corrosion resistant 3/16" dia. or # 10 bolts, backed by a flat washer, and secured to the mounting surface with a split-ring lock washer.
2. Hold the charger to the mounting surface and mark the holes.
3. Remove the charger and drill the mounting holes.
4. Align the charger and assemble the mounting hardware. Secure.

Making DC Connections

Check polarity of the battery posts. The POSITIVE (POS., P, +) battery post usually has a larger diameter than the NEGATIVE (NEG., N, -) post. Connect Red charger output wire to POSITIVE post, Black charger wire to NEGATIVE. See below diagrams for more details.

Battery Size Recommendations

The recommended maximum battery size per 3 amp bank is 36AH.

The recommended maximum battery size per 5 amp bank is 60AH.

The recommended maximum battery size per 6 amp bank is 72AH.

2607A Connections

Model	Output Volts	Output Amps	Banks	DC Cable Size	Size (inches) L x W x H	Input Volts	Input Amps Max
2607A	12/24	3/3	2	4'/4'	3.5 x 6.4 x 2.25	115VAC 50/60Hz	2 Amp

Diagram 1. 2607A (3/3 Amps) used with 2 independent 12V Batteries

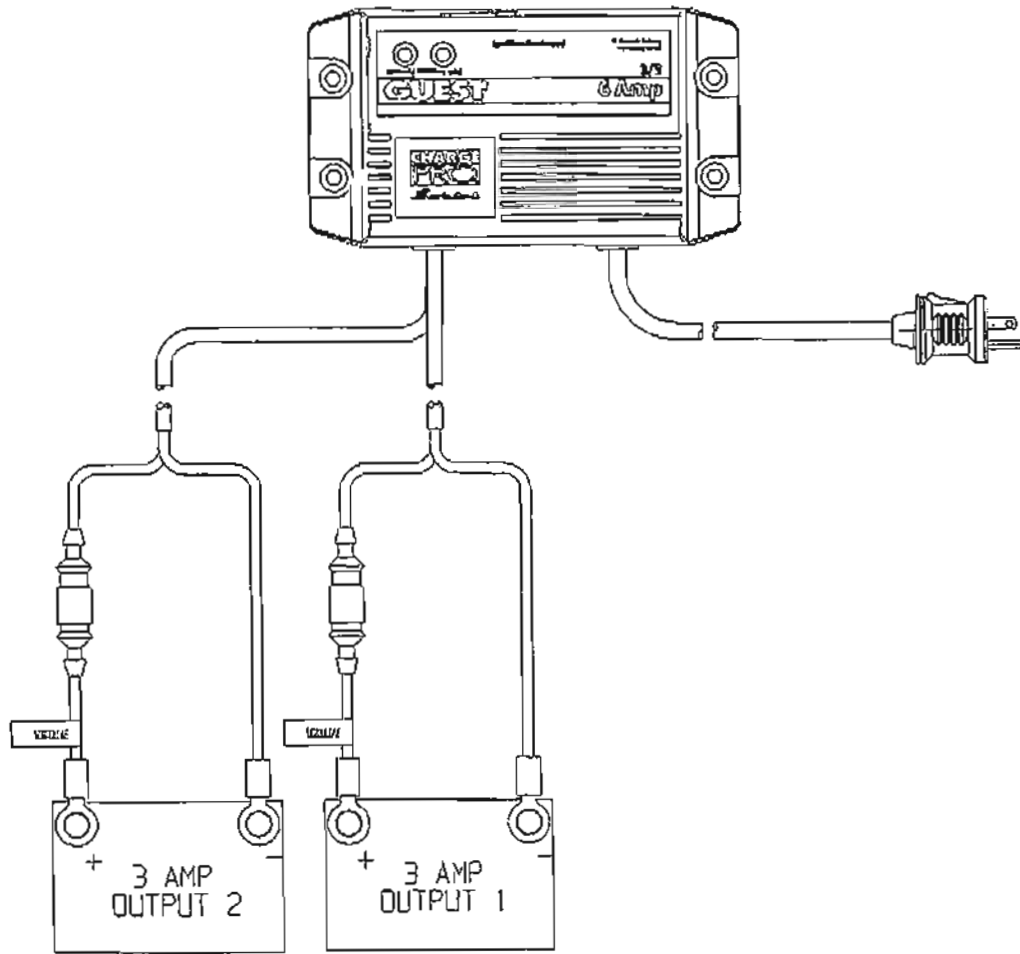

2607A Connection Warnings: For the 2607A, output 1 and output 2 may be connected in parallel for a 12 V 6 amp output. Both outputs may also be connected in series for a 24 V output, see below.

2607A Connections

Diagram 2. 2607A used in a 24V system

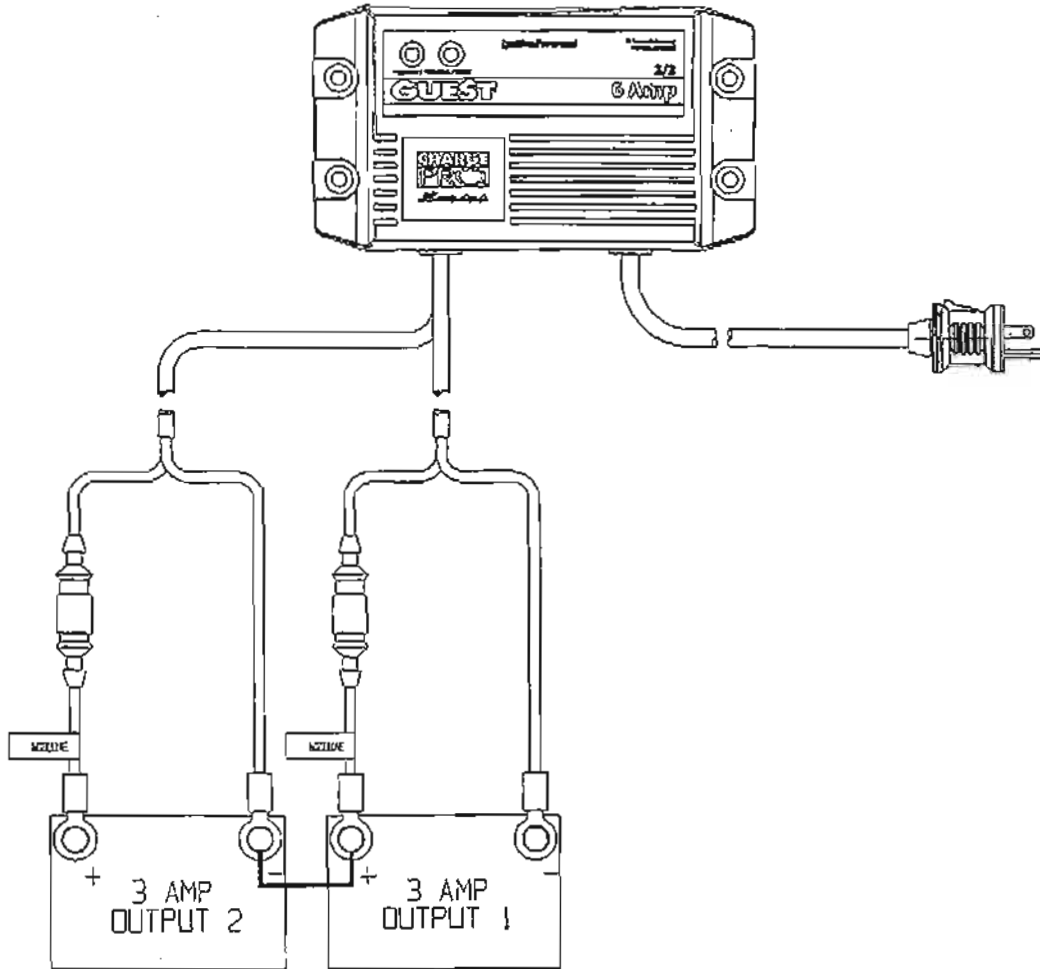

2608A Connections

Model	Output Volts	Output Amps	Banks	DC Cable Size	Size (inches) L x W x H	Input Volts	Input Amps Max
2608A	12	6	1	4'	3.5 x 6.4 x 2.25	115VAC 50/60Hz	2 Amps

Diagram 3. 2608A (6 Amps) used with 1 12V Battery

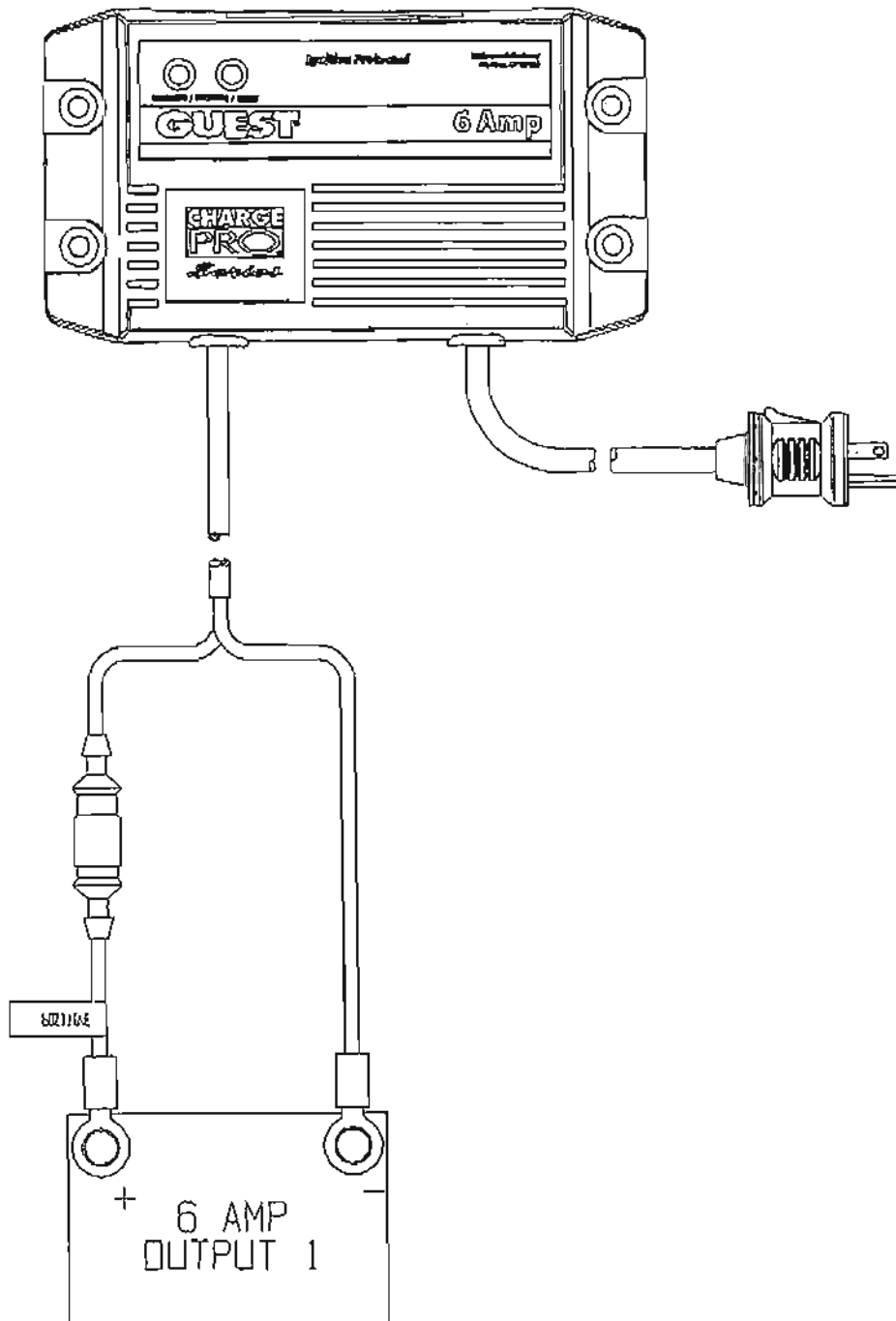

2611A Connections

Model	Output Volts	Output Amps	Banks	DC Cable Size	Size (inches) L x W x H	Input Volts	Input Amps Max
2611A	12/24	5/5	2	4/4'	4.25 x 7 x 2.42	115VAC 50/60Hz	2.5 Amps

Diagram 4. 2611A (5/5 Amps) used with 2 independent 12V Batteries

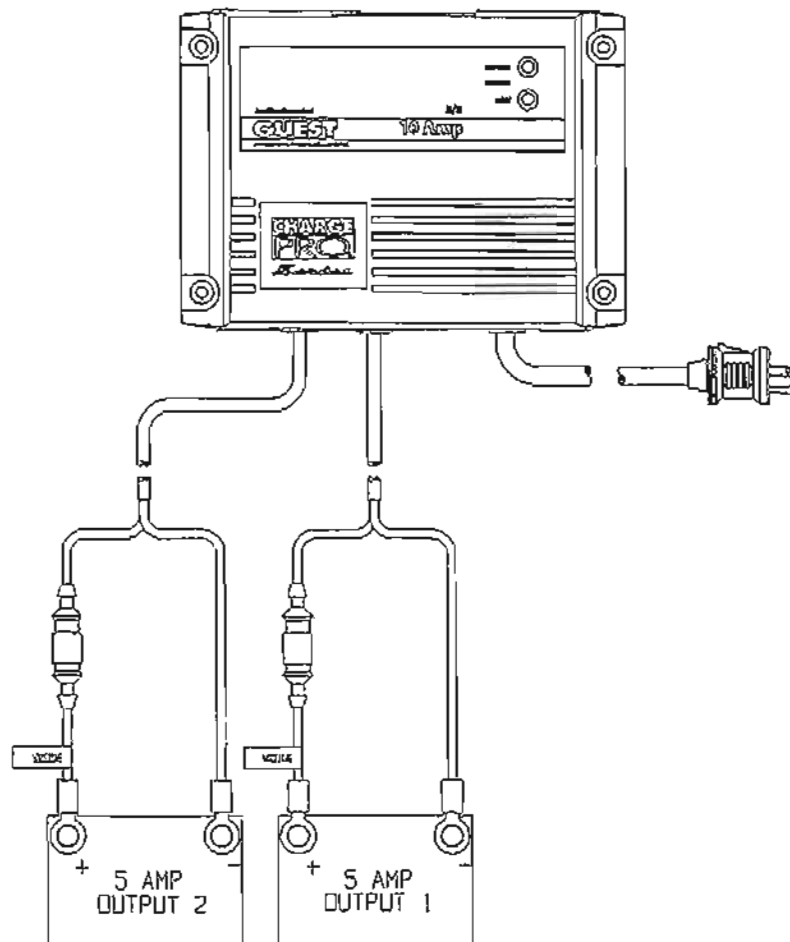

2611A Connections: For the 2611A, Output 1 and output 2 may be connected in parallel for a 12 V 10 amp output. Output 1 and 2 may be connected in series for a 24 V system, see below.

2611A Connections

Diagram 5: 2611A used in a 24 V system

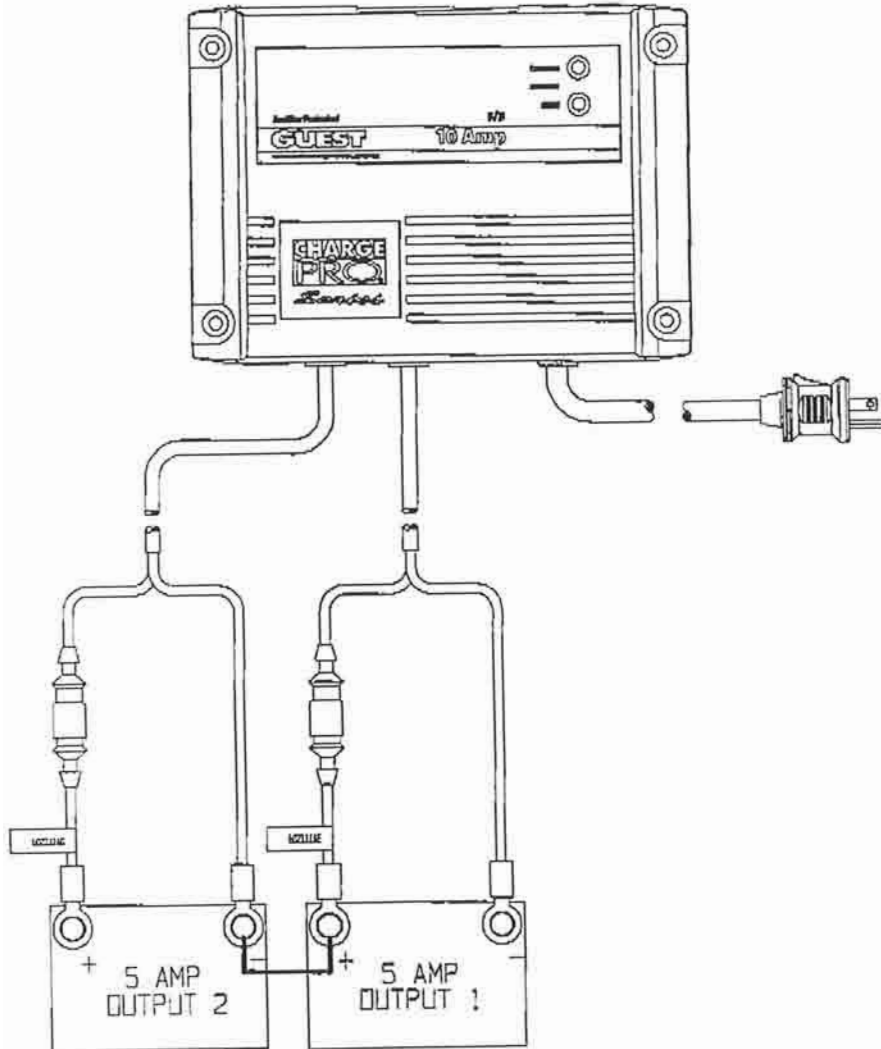

2610A Connections

Model	Output Volts	Output Amps	Banks	DC Cable Size	Size (inches) L x W x H	Input Volts	Input Amps Max
2610A	12	5/5	2	N/A	4.25 x 7 x 2.42	115VAC 50/60Hz	2.5 Amps

Diagram 6: 2610A (5/5 Amps) used with 2 12V Batteries

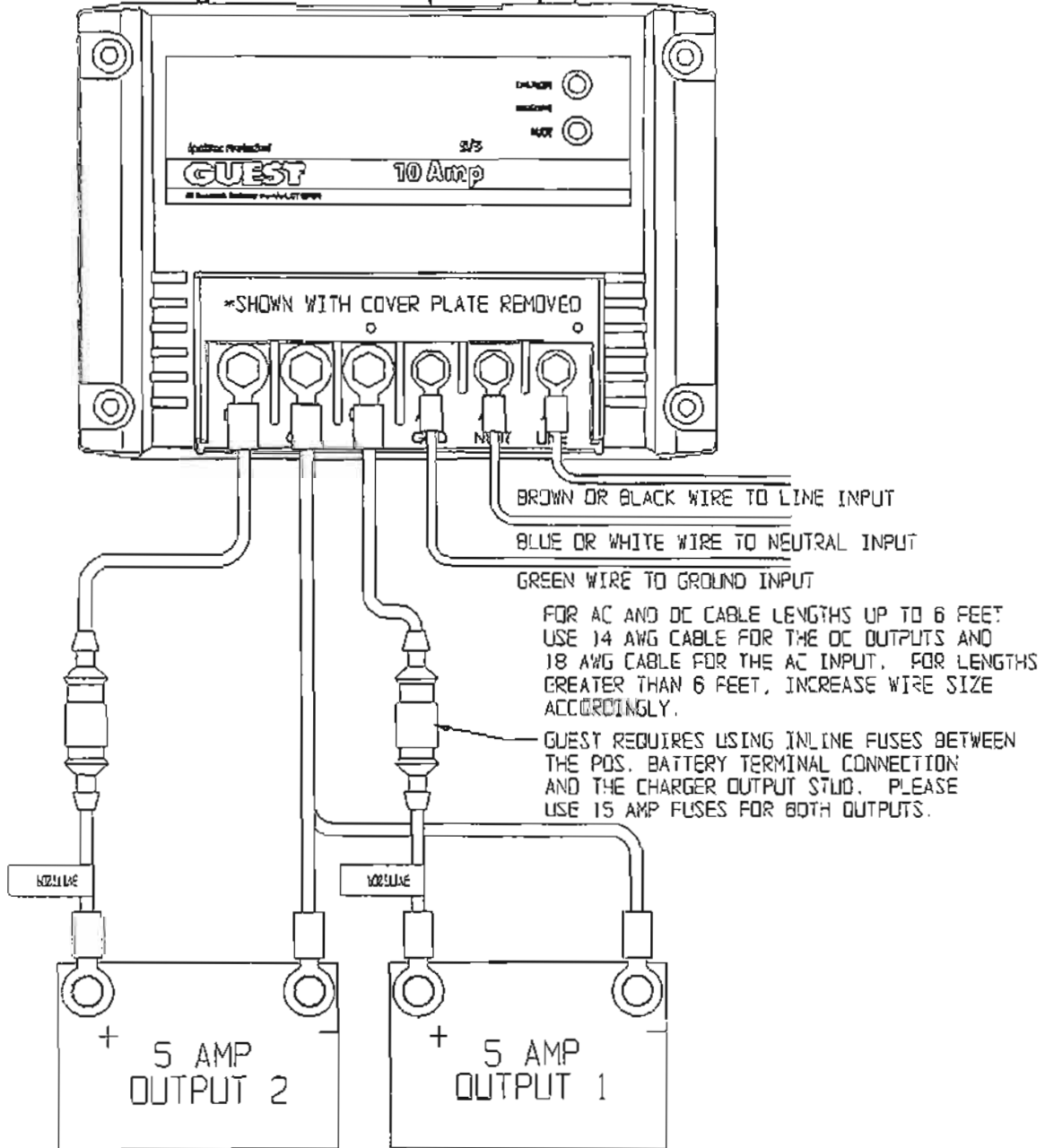

2610A Connections: The 2610A can be used on 2 12 volt independent batteries. It may NOT be used for a 24 Volt system, the outputs may NOT be wired in series. The 2610A may be used to charge one single battery. When doing this, a 12 Gauge jumper wire must be added between output posts DC + #1 and DC + #2. See diagram below.

2610A Connections



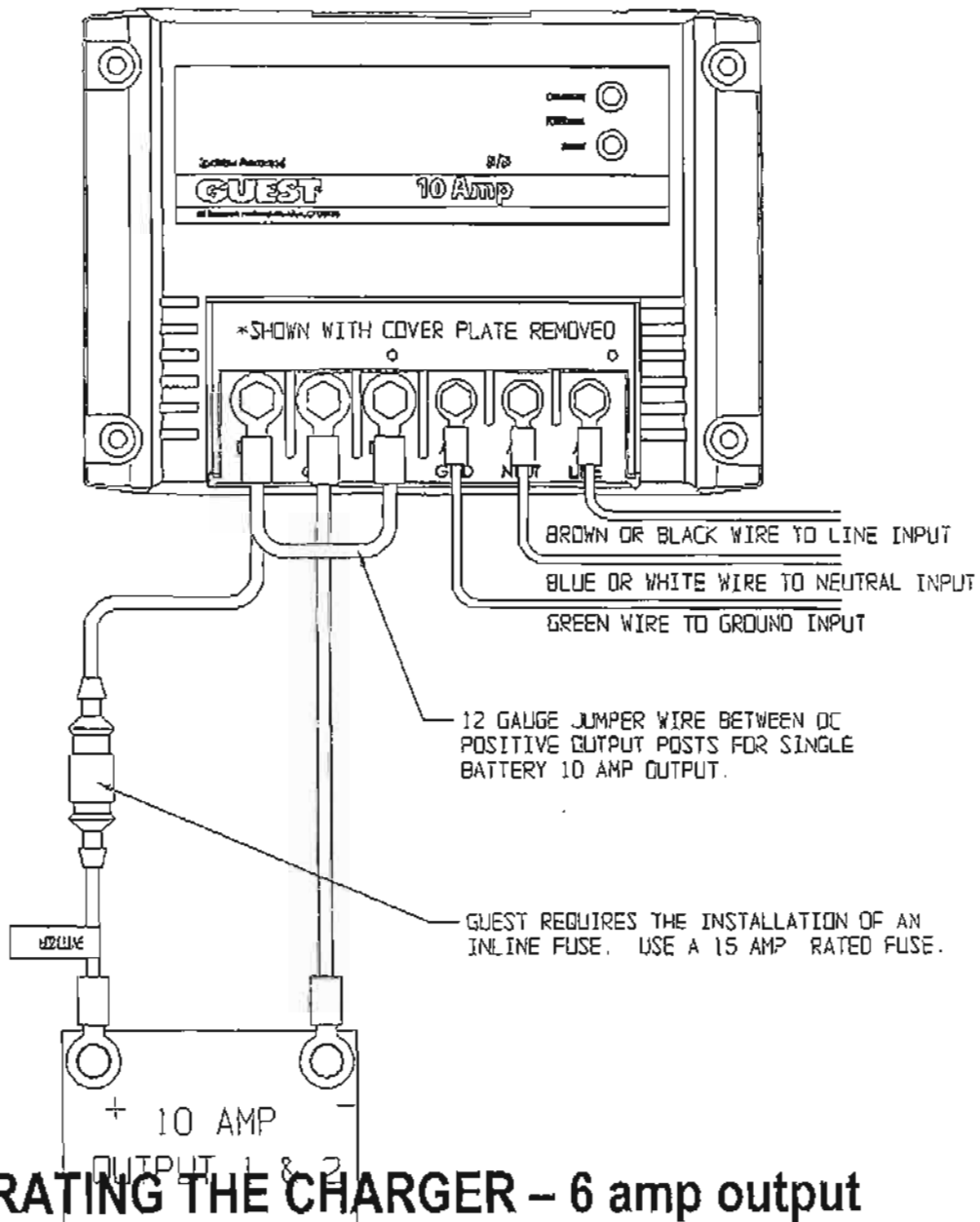



Diagram 7: 2610A used in a single battery system



3. OPERATING THE CHARGER – 6 amp output

The LED Function Chart describes the charging process for any individual 6 Amp output.







Display	Operating condition
---------	---------------------

<p>Red </p> <p>Green </p>	<p>When the red LED is on, it indicates that your batteries are discharged and is recharging them at the "Charging" rate (stage 1). This charging rate is 6 Amps.</p> <p>While the red LED is on, the voltage measured (with the charger on) will be approximately 11.5 to 13 Volts.</p> <p>If the red LED stays on for more than 24 hours, refer to Problem 1 in the troubleshooting section in this manual.</p>
<p>Red </p> <p>Green </p>	<p>When both the green and the red LED's are on, it is charging at the "Finishing" rate. (stage 2). During this second charging stage, the charger holds the battery voltage at approximately 14.6 VDC, and then gradually reduces the amount of current (Amps) it delivers to the battery. By doing this, the battery is able to "absorb" the last 10% of charge as quickly as possible without becoming overheated.</p> <p>If both lights stay on longer than 24 hours, refer to Problem 2 in the troubleshooting section in this manual.</p>
<p>Red </p> <p>Green </p>	<p>When the battery approaches full charge, the charger switches into its third charging stage, gradually reducing the current feed to the batteries to as low as 0.1 Amps. At the same time, it reduces its output voltage to a "Float" or "Ready" charging rate of 13.3 VDC, indicated by the green LED light. This low "Float" or "Maintenance" voltage gently "tops off" your batteries, keeping them fully charged and ready until needed. The green LED indicates that your batteries are now fully charged and ready for use.</p> <p>If the green LED stays on when your battery is known to be low, refer to Problem 3 in the troubleshooting section in this manual.</p>

OPERATING THE CHARGER – 5 amp output

The LED Function Chart describes the charging process for any individual 5 Amp output.







Display	Operating condition
---------	---------------------

<p>Red </p> <p>Green </p>	<p>When the red LED is on, it indicates that your batteries are discharged and is recharging them at the "Charging" rate (stage 1). This charging rate is 5 Amps.</p> <p>While the red LED is on, the voltage measured (with the charger on) will be 11.5 to 13 Volts.</p> <p>If the red LED stays on for more than 24 hours, refer to Problem 1 in the troubleshooting section in this manual.</p>
<p>Red </p> <p>Green </p>	<p>When both the green and the red LED's are on, it is charging at the "Finishing" rate. (stage 2). During this second charging stage, the charger holds the battery voltage at approximately 14.3 VDC, and then gradually reduces the amount of current (Amps) it delivers to the battery. By doing this, the battery is able to "absorb" the last 10% of charge as quickly as possible without becoming overheated.</p> <p>If both lights stay on longer than 24 hours, refer to Problem 2 in the troubleshooting section in this manual.</p>
<p>Red </p> <p>Green </p>	<p>When the battery approaches full charge, the charger switches into its third charging stage, gradually reducing the current feed to the batteries to as low as 0.1 Amps. At the same time, it reduces its output voltage to a "Float" or "Ready" charging rate of 13.3 VDC, indicated by the green LED light. This low "Float" or "Maintenance" voltage gently "tops off" your batteries, keeping them fully charged and ready until needed. The green LED indicates that your batteries are now fully charged and ready for use.</p> <p>If the green LED stays on when your battery is known to be low, refer to Problem 3 in the troubleshooting section in this manual.</p>

OPERATING THE CHARGER – 3 amp output

The LED Function Chart describes the charging process for any individual 3 Amp output.

Display	Operating condition
---------	---------------------

<p>Red </p> <p>Green </p>	<p>When the red LED is on, it indicates that your batteries are discharged and is recharging them at the "Charging" rate (stage 1). This charging rate is 3 Amps.</p> <p>While the red LED is on, the voltage measured (with the charger on) will be 11.5 to 13 Volts.</p> <p>If the red LED stays on for more than 24 hours, refer to Problem 1 in the troubleshooting section in this manual.</p>
<p>Red </p> <p>Green </p>	<p>When both the green and the red LED's are on, it is charging at the "Finishing" rate. (stage 2). During this second charging stage, the charger holds the battery voltage at approximately 14.6 VDC, and then gradually reduces the amount of current (Amps) it delivers to the battery. By doing this, the battery is able to "absorb" the last 10% of charge as quickly as possible without becoming overheated.</p> <p>If both lights stay on longer than 24 hours, refer to Problem 2 in the troubleshooting section in this manual.</p>
<p>Red </p> <p>Green </p>	<p>When the battery approaches full charge, the charger switches into its third charging stage, gradually reducing the current fed to the batteries to as low as 0.1 Amps. At the same time, it reduces its output voltage to a "Float" or "Ready" charging rate of 13.3 VDC, indicated by the green LED light. This low "Float" or "Maintenance" voltage gently "tops off" your batteries, keeping them fully charged and ready until needed. The green LED indicates that your batteries are now fully charged and ready for use.</p> <p>If the green LED stays on when your battery is known to be low, refer to Problem 3 in the troubleshooting section in this manual.</p>

4. TROUBLESHOOTING

Problem	Cause	Solution
---------	-------	----------

<ol style="list-style-type: none"> 1. Red LED stays on for more than 24 Hrs. 	<ol style="list-style-type: none"> 1. One or more defective or damaged cells. 2. Charger has reduced its output voltage below the normal level due to a DC overload or a DC short. 3. On-board DC systems are drawing more current than the charger can replace. 	<ol style="list-style-type: none"> 1. Load test the batteries and replace if necessary. 2. Remove the source of the overload or short. Disconnect the charger's black (NEGATIVE) ring terminal from the battery. Reapply AC power and the green LED only should now light. 3. Turn off all DC equipment while charging.
<ol style="list-style-type: none"> 2. The red and green LED's stay on for more than 24 Hrs. 	<ol style="list-style-type: none"> 1. On-board DC systems are drawing between 1.5 – 3.5A. 2. One or more defective or damaged cells. 3. Extremely low AC voltage at the battery charger. 	<ol style="list-style-type: none"> 1. Turn off all DC equipment while charging. 2. Load test the batteries and replace if necessary. 3. Apply a higher AC voltage source or reduce the length of the extension cord. 4. Check battery manufacturer's specs on battery charging.
<ol style="list-style-type: none"> 3. Green LED stays on when the battery is known to be low. 	<ol style="list-style-type: none"> 1. Open circuit breaker or DC output fuse. 2. Faulty or contaminated terminal connections. 3. One or more defective or damaged cells. 	<ol style="list-style-type: none"> 1. Check connections to the battery, reset circuit breaker if equipped/replace fuse.. 2. Clean and tighten or repair all terminal connections. 3. Load test the batteries and replace if necessary.
<ol style="list-style-type: none"> 3. Neither of the LED's turn on when the AC power is applied. 	<ol style="list-style-type: none"> 1. No AC power available at the charger 2. Charger failure 	<ol style="list-style-type: none"> 1. Connect AC power or reset the AC breaker on the main panel 2. Return charger to the Guest Service Dept.

5. MAINTAINING THE CHARGER

Periodically clean both battery terminals with baking soda and tighten all connections. No other maintenance on the charger is required.

6. SPECIFICATIONS

Model	Output Volts	Output Amps	Banks	DC Cable Size	Size (inches) L x W x H	Input Volts	Input Amps Max
-------	--------------	-------------	-------	---------------	----------------------------	-------------	----------------

2607A	12/24	3/3	2	4'¼'	3.5 x 6.4 x 2.25	115VAC 50/60Hz	2 Amps
2608A	12	6	1	4'	3.5 x 6.4 x 2.25	115VAC 50/60Hz	2 Amps
2610A	12	5/5	2	N/A	4.25 x 7 x 2.42	115VAC 50/60Hz	2.5 Amps
2611A	12/24	5/5	2	4'¼'	4.25 x 7 x 2.42	115VAC 50/60Hz	2.5 Amps

FCC Class A EMC Notice

This equipment has been tested and found to comply with the limits for a Class A digital device, pursuant to part 15 of the FCC Rules. These limits are designed to provide reasonable protection against harmful interference when the equipment is operated in a commercial environment. This equipment generates, uses and can radiate radio frequency energy and, if not installed and used in accordance with the instructions, may cause harmful interference to radio communications. Operation of this equipment in a residential area is likely to cause harmful interference in which case the user will be required to correct the interference at his own expense.

If this equipment does cause harmful interference to radio or television reception, which can be determined by turning this equipment off and on, the user is encouraged to try to correct the interference by one or more of the following measures:

- Reorient or relocate the receiving antenna.
- Increase the separation between the equipment and receiver.
- Connect the equipment into an outlet on a circuit different from that to which the receiver is connected.

LIMITED WARRANTY

For two (2) years from the date of purchase, The Guest Co. will, at its discretion, repair or replace for the original consumer, free of charge, any parts found defective in material or workmanship.

This product is guaranteed for life against water damage.

Proof of purchase is required: A computerized register receipt is required. Hand-written receipts are not accepted for warranty proof of purchase.

There is no other expressed warranty. Implied warranties, including those of merchantability and fitness for a particular purpose, are limited to one year from the date of purchase. This is the exclusive remedy and consequential damages are excluded where permitted by law.

The Guest Co.
95 Research Parkway
Meriden, CT 06450, USA

Tel: (203) 235-4421 Fax: (203) 235-0039

Email: info@questco.com

Website: www.questco.com